

The Patent Drawings Company

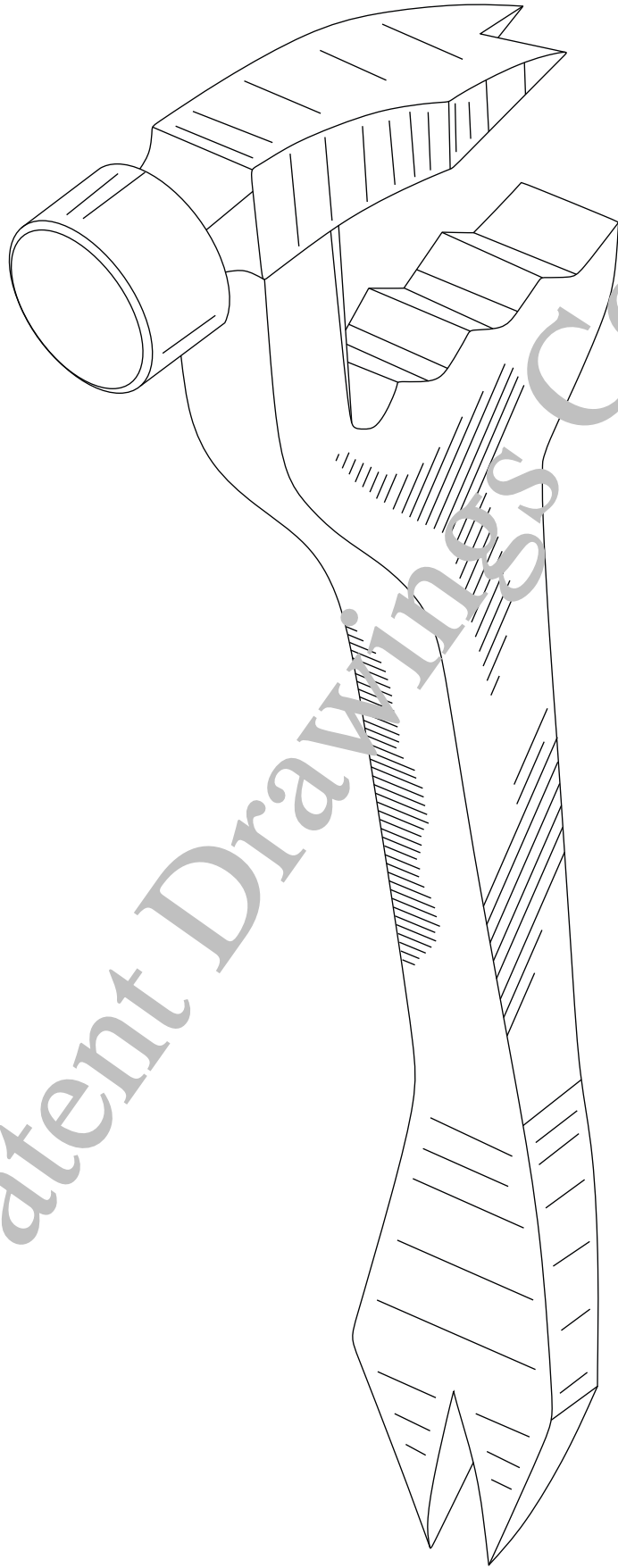

The Patent Drawings Company

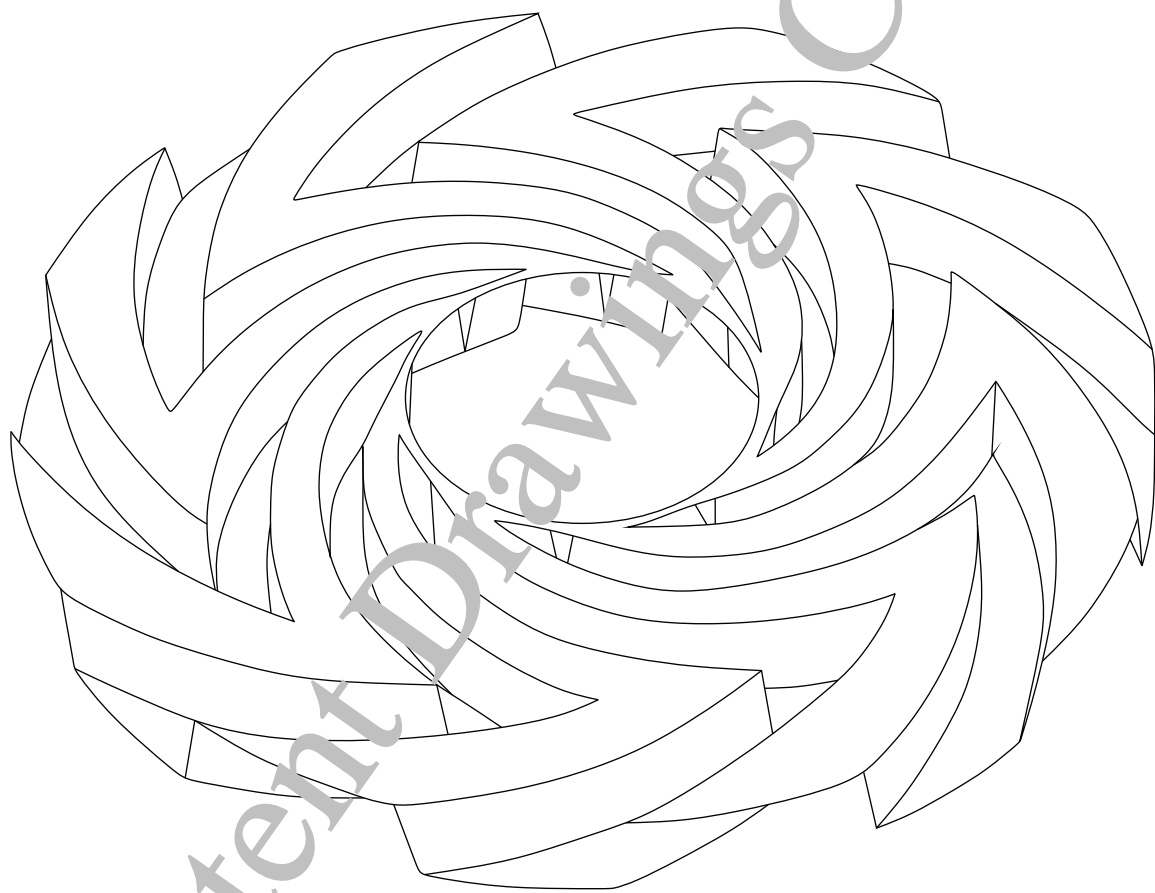

The Patent Drawings Company

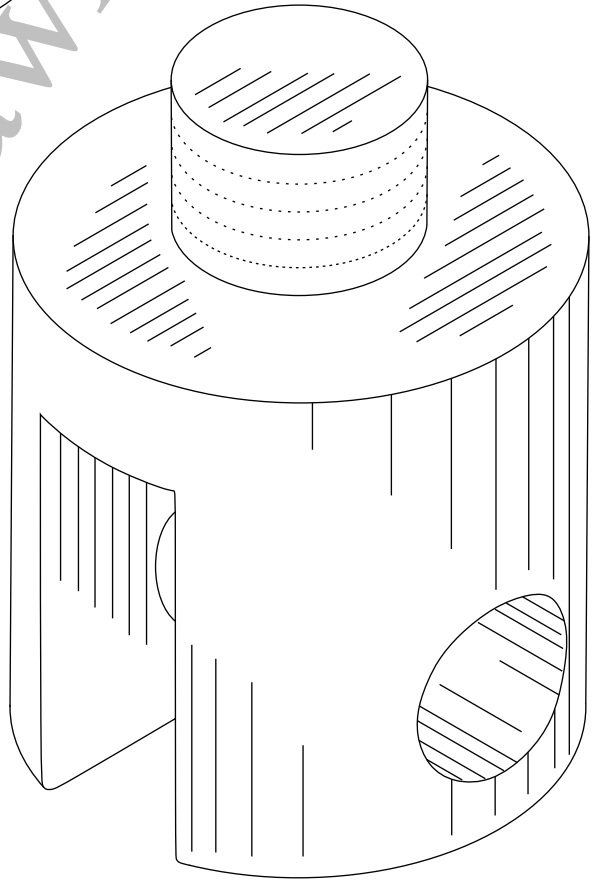
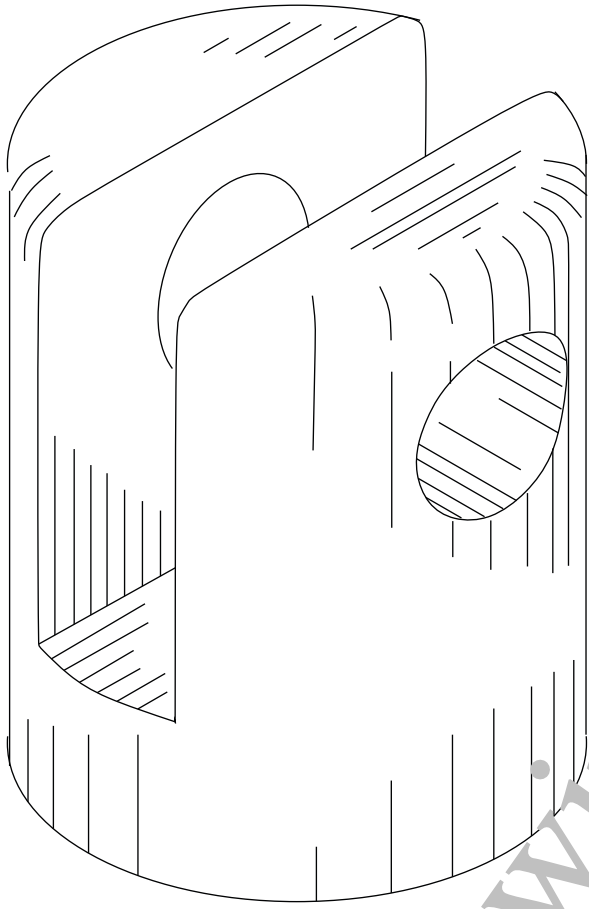

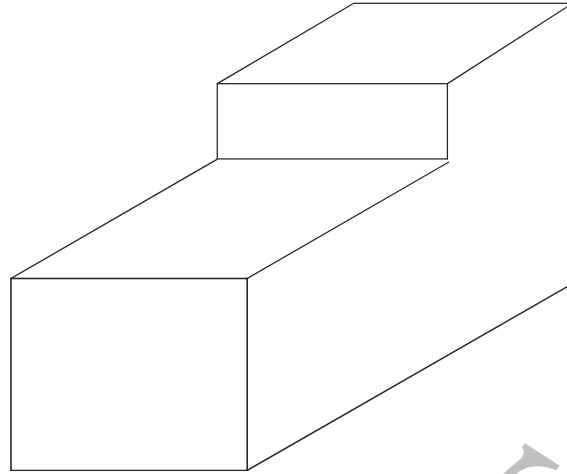

*Perspective view*

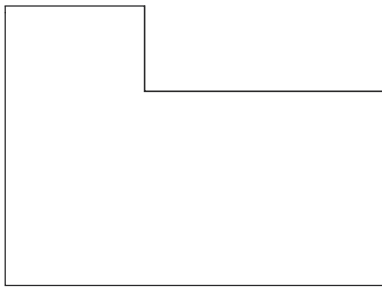

*Back View*

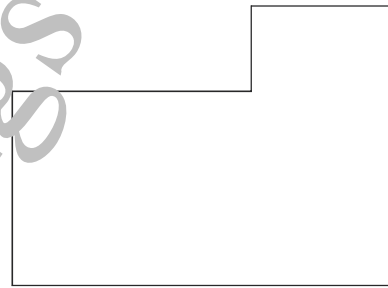

*Front View*



*Left Side View*

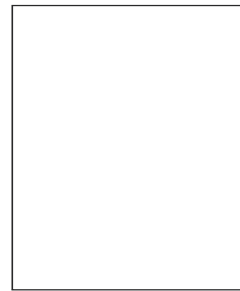

*Right Side View*

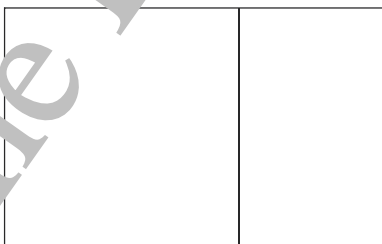

*Top View*



*Bottom View*

The Patent Drawings Company

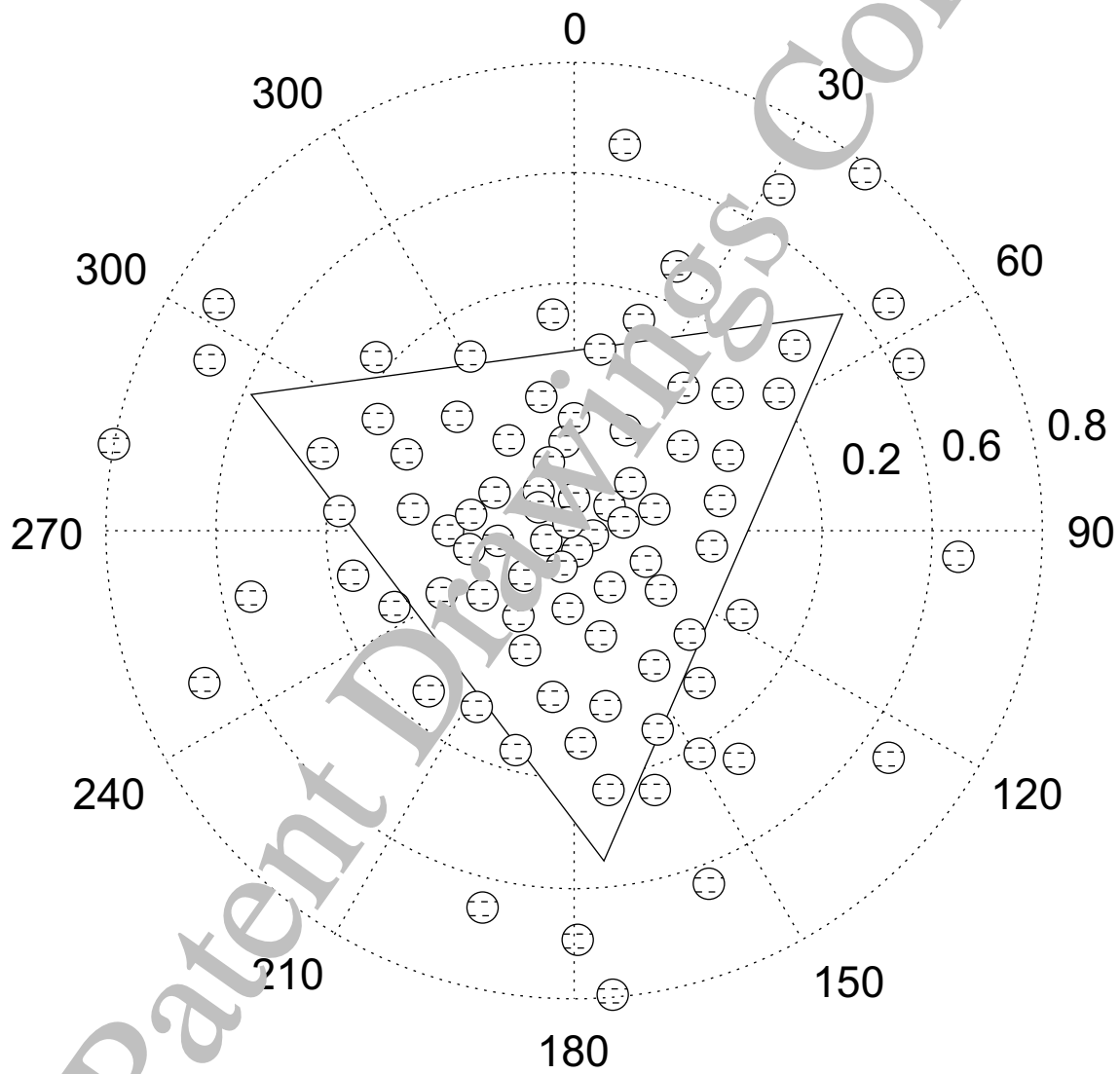

The Patent Drawings Company

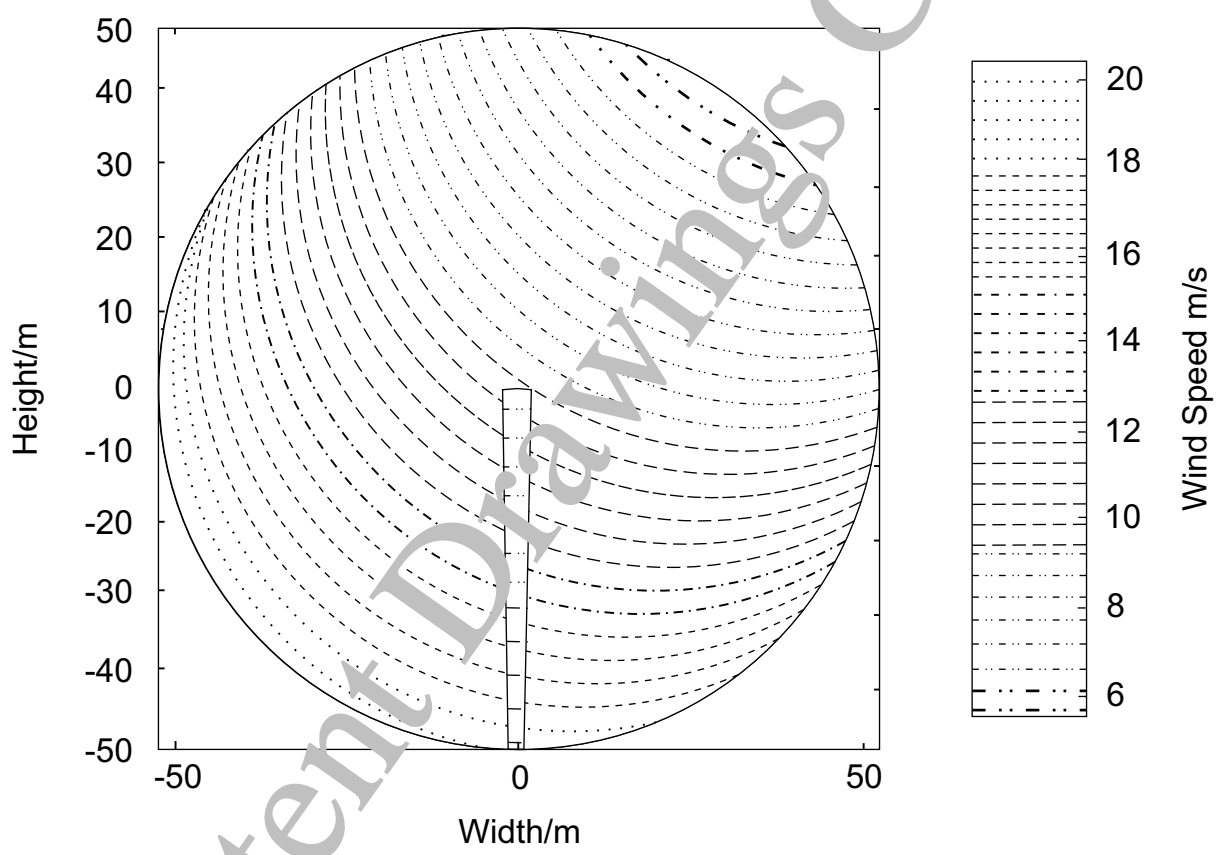

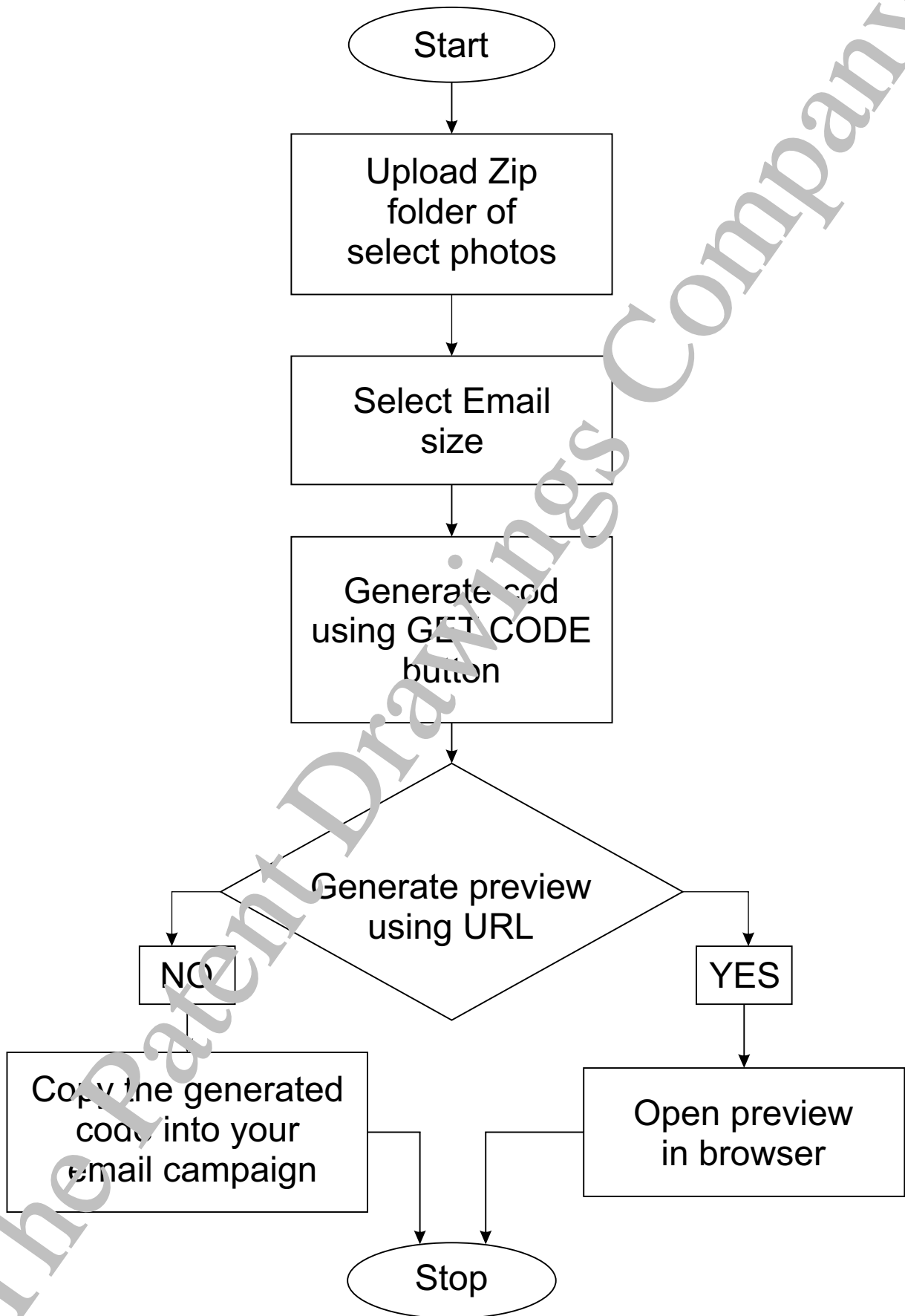

The Patent Drawings Company

